

DSH Single/Dual Release & Drop for Phantom 4 / Phantom 3 series drones

Model numbers: DSH-SRD1-P4, DSH-DRD1-P4, DSH-SRD1-P3, DSH-DRD1-P3

DSH Single/Dual Release & Drop PLUS for Phantom 4 / Phantom 3 series drones

Model numbers: DSH-SRDP1-P4, DSH-DRDP1-P4, DSH-SRDP1-P3, DSH-DRDP1-P3

Operation Guide v1.1

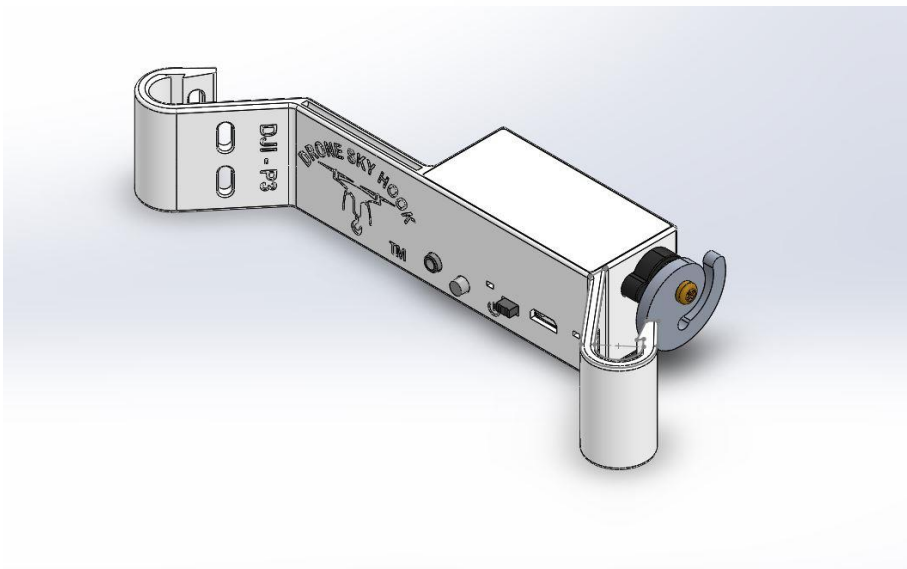
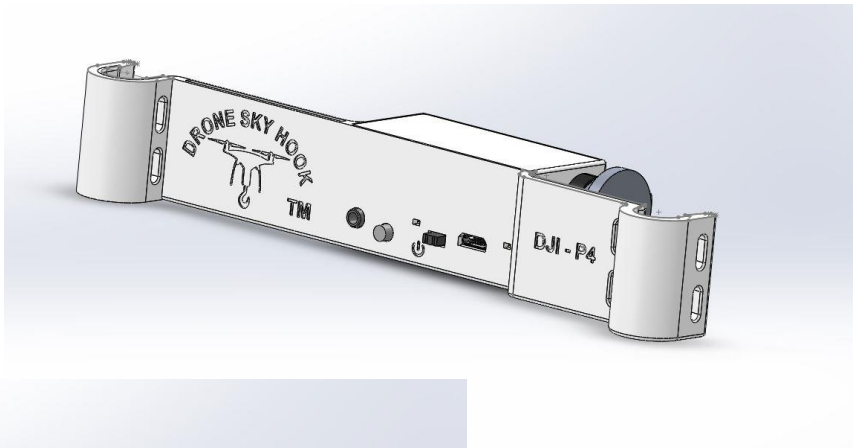

Controlling the Single Drop Wheel

DSH Models: Single Release & Drop / Single Release & Drop PLUS

Operation Mode 1 – Drone Rotation

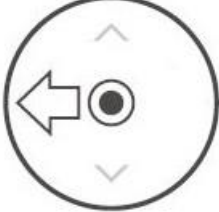
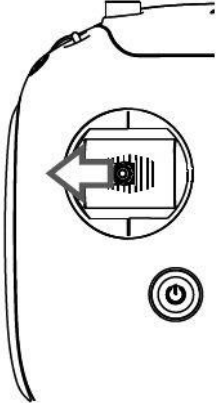
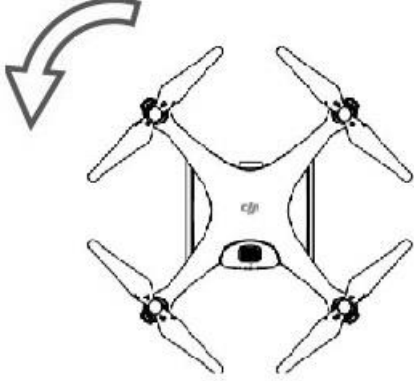
Remote Controller (Mode 2) LEFT STICK	Operation
	<p>Quickly Rotate (YAW) the drone two full turns counter clockwise to drop the payload.</p> <p>To set the drop wheel back to its previous position, Quickly Rotate (YAW) the drone again two full turns counter clockwise.</p>
	

Operation Mode 2 – Drone Remote Controller C1/C2 Button and/or DJI App

Note: Use the DJI App to assign C1 or C2 button to Turn On/Off front LEDs

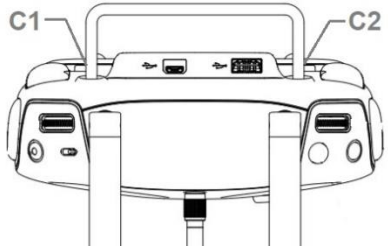
Remote Controller C1 / C2 Button	Operation
	<p>Press C1 or C2 twice in quick succession (while maintaining about 0.5-1 second between each press) to drop the payload.</p> <p>To set the drop wheel back to its previous position, again press C1 or C2 twice in quick succession (while maintaining about 0.5-1 second between each press).</p>

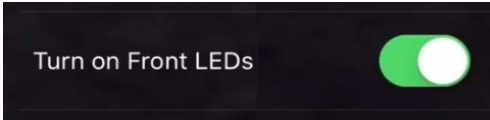
DJI App	Operation
<p>Settings – Main Controller Settings – Advanced Settings</p> 	<p>In the App menu switch the drone's front LEDs ON and then OFF or OFF and then ON. (Total of one ON-OFF or OFF-ON cycle) to simulate the operation of the C1 or C2 buttons on the drone's remote controller (see above).</p> <p>Maintain about 0.5-1 second idle duration between each switch operation.</p>

Operation Mode 3 – Manual – FUNC button on DSH unit

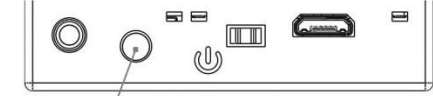
DSH Release & Drop unit	Operation
	<p>Press twice the device's FUNC button to simulate the operation of the C1 or C2 buttons on the drone's remote controller (see above).</p> <p>Maintain about 0.5-1 second idle duration between each operation of the FUNC button.</p>

IMPORTANT NOTE: At the end of each operation wait 3 seconds for the execution your command and before the initiation of the next command (False Command Avoidance Algorithm (FCAA)).

Controlling the Dual Drop Wheel

DSH Models: Dual Release & Drop / Dual Release & Drop PLUS

Operation Mode 1 – Drone Rotation

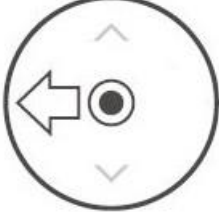
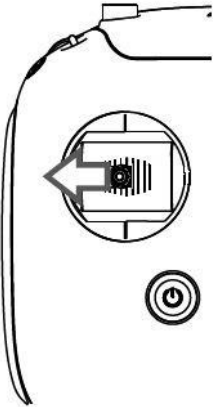
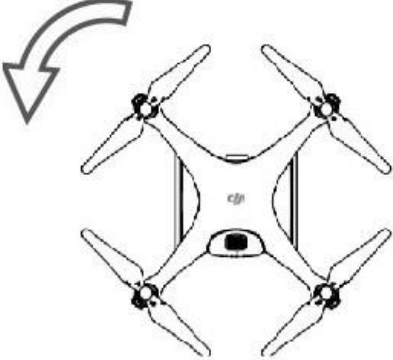
Remote Controller (Mode 2) LEFT STICK	Operation
	<p>Quickly Rotate (YAW) the drone two full turns counter clockwise to drop the first payload.</p> <p>Quickly Rotate (YAW) the drone again two full turns counter clockwise to drop the second payload.</p> <p>To set the drop wheel back to its previous position, Quickly Rotate (YAW) the drone again two full turns counter clockwise.</p>
	

Operation Mode 2 – Drone Remote Controller C1/C2 Button and/or DJI App

Note: Use the DJI App to assign C1 or C2 button to Turn On/Off front LEDs

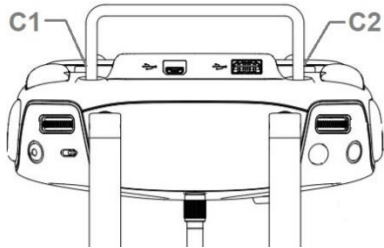
Remote Controller C1 / C2 Button	Operation
	<p>Press C1 or C2 twice in quick succession (while maintaining about 0.5-1 second between each press) to drop the first payload.</p> <p>Press C1 or C2 twice again in quick succession (while maintaining about 0.5-1 second between each press) to drop the second payload.</p> <p>To set the drop wheel back to its previous position, again press C1 or C2 twice in quick succession (while maintaining about 0.5-1 second between each press).</p>

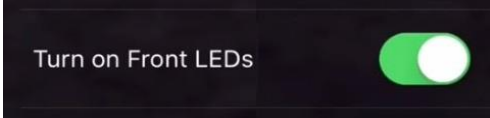
DJI App	Operation
<p>Settings – Main Controller Settings – Advanced Settings</p> 	<p>In the App menu switch the drone's front LEDs ON, then OFF and then back ON or OFF, then ON and then OFF. (Total of one ON-OFF-ON or OFF-ON-OFF cycle) to simulate the operation of the C1 or C2 buttons on the drone's remote controller (see above).</p> <p>Maintain about 0.5-1 second idle duration between each switch operation.</p>

Operation Mode 3 – Manual – FUNC button on DSH unit

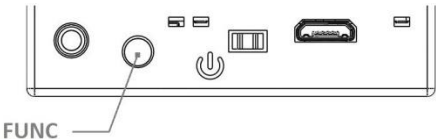
DSH Release & Drop unit	Operation
	<p>Press twice the device's FUNC button to simulate the operation of the C1 or C2 buttons on the drone's remote controller (see above).</p> <p>Maintain about 0.5-1 second idle duration between each operation of the FUNC button.</p>

IMPORTANT NOTE: At the end of each operation wait 3 seconds for the execution your command and before the initiation of the next command (False Command Avoidance Algorithm (FCAA)).

Controlling the AUX Channel (DSH PLUS models only)

DSH Models: Single Release & Drop PLUS / Dual Release & Drop PLUS

Operation Mode 1 – Drone Rotation

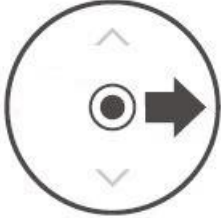
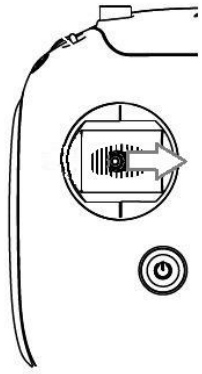
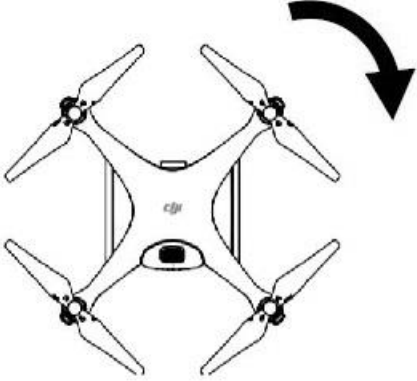
Remote Controller (Mode 2) LEFT STICK	Operation
	<p>Quickly Rotate (YAW) the drone two full turns clockwise to command the AUX Channel to turn ON.</p> <p>Quickly Rotate (YAW) the drone again two full turns clockwise to command the AUX Channel to turn OFF.</p>
	

Operation Mode 2 – Drone Remote Controller C1/C2 Button and/or DJI App

Note: Use the DJI App to assign C1 or C2 button to Turn On/Off front LEDs

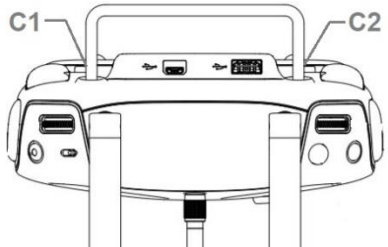
Remote Controller C1 / C2 Button	Operation
	<p>Press C1 or C2 three times in quick succession (while maintaining about 0.5-1 second between each press) to command the AUX Channel to turn ON.</p> <p>Press C1 or C2 three times again in quick (while maintaining about 0.5-1 second between each press) to command the AUX Channel to turn OFF.</p>

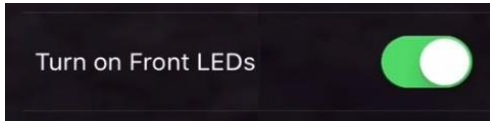
DJI App	Operation
<p>Settings – Main Controller Settings – Advanced Settings</p> 	<p>In the App menu switch the drone's front LEDs ON, then OFF and then back ON or OFF, then ON and then OFF. (Total of one ON-OFF-ON or OFF-ON-OFF cycle) to simulate the operation of the C1 or C2 buttons on the drone's remote controller (see above).</p> <p>Maintain about 0.5-1 second idle duration between each switch operation.</p>

Operation Mode 3 – Manual – FUNC button on DSH unit

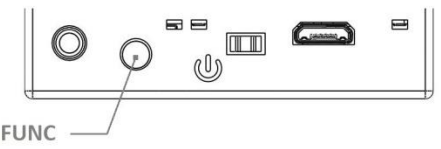
DSH Release & Drop unit	Operation
	<p>Press three times the device's FUNC button to simulate the operation of the C1 or C2 buttons on the drone's remote controller (see above).</p> <p>Maintain about 0.5-1 second idle duration between each operation of the FUNC button.</p>

IMPORTANT NOTE: At the end of each operation wait 3 seconds for the execution your command and before the initiation of the next command (False Command Avoidance Algorithm (FCAA)).